

Bevel Gear Boxes Model 2726 - REFERENCE SHEETS

Other Models Available. For Instant Data, see www.vonruden.com.



07.08.03

- Rugged Cast Iron housing. • Weight = 12 lbs. (approx.) • Oil Capacity = 6 oz. (approx.)

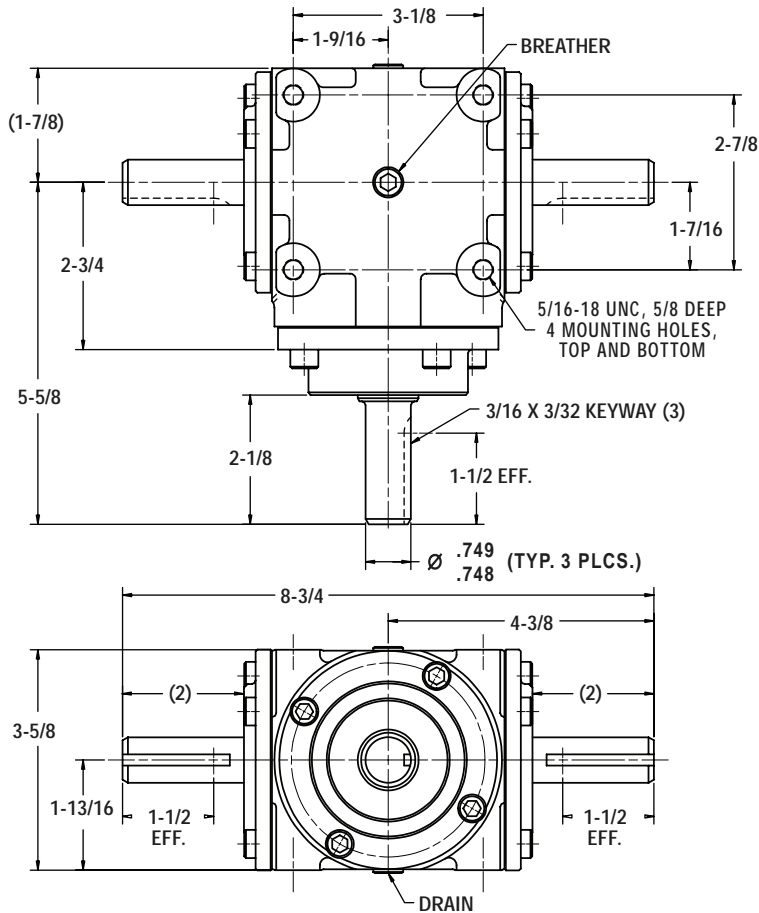

Model 2726-117 Shown Above

MODEL NUMBERS		SHAFT ARRANGEMENT AND ROTATION					
		Type A	Type B	Type C	Type D	Type E	Type G
Gear Type	Gear Ratio						
Straight Cut	1:1 Reduction	2726-100	2726-101	2726-101	2726-100	2726-102	2726-102
	1.5:1 Reduction	2726-103	2726-104	2726-104	2726-103	2726-105	2726-105
	2:1 Reduction	2726-106	2726-107	2726-107	2726-106	2726-108	2726-108
Straight Cut	1:1.5 Speed Up	2726-109	2726-110	2726-110	2726-109	2726-111	2726-111
	1:2 Speed Up	2726-112	2726-113	2726-113	2726-112	2726-114	2726-114
Spiral	1:1 Reduction	2726-115	2726-116	2726-116	2726-115	2726-117	2726-117
	3:1 Reduction	2726-118	2726-119	2726-119	2726-118	2726-120	2726-120

Bevel Gear Boxes Model 2726 – REFERENCE SHEETS

Other Models Available. For Instant Data, see www.vonruden.com.



07.08.03

Gear Type & Ratio		MAXIMUM HORSEPOWER RATINGS (1.0 SERVICE FACTOR)									
		Input RPM									
		10	100	300	540	700	1000	1200	1750	2500	3000
Straight Cut 1:1 Reduction	Gear Strength	0.12	1.2	3.6	5.9	8.3	11.8	14.1	20	**	**
	1000 hr L ₁₀	*	*	3.1	4.3	5.4	6.8	7.8	10	**	**
	5000 hr L ₁₀	*	0.8	1.8	2.5	3.2	4.0	4.5	6	**	**
Straight Cut 1.5:1 Reduction	Gear Strength	0.08	0.8	2.5	4.2	5.9	8.3	10.0	15	21	25
	1000 hr L ₁₀	*	*	1.8	2.5	3.2	4.0	4.5	6	7	8
	5000 hr L ₁₀	*	0.5	1.0	1.5	1.8	2.3	2.6	3.4	4.3	4.9
Straight Cut 2:1 Reduction	Gear Strength	0.05	0.5	1.4	2.4	3.4	4.8	5.7	8	12	14
	1000 hr L ₁₀	*	*	1.3	1.8	2.2	2.8	3.2	4	5	6
	5000 hr L ₁₀	*	0.3	0.7	1.0	1.3	1.6	1.9	2.4	3.1	3.5
Straight Cut 1:1.5 Speed up	Gear Strength	0.11	1.1	3.2	5.4	7.5	10.7	12.8	19	**	**
	1000 hr L ₁₀	*	*	*	4.6	5.8	7.3	8.2	11	**	**
	5000 hr L ₁₀	*	0.9	1.9	2.7	3.4	4.3	4.8	6.2	**	**
Straight Cut 1:2 Speed up	Gear Strength	0.07	0.7	2.2	3.7	5.1	7.3	8.7	13	**	**
	1000 hr L ₁₀	*	*	*	*	*	*	*	11	**	**
	5000 hr L ₁₀	*	*	2.0	2.8	3.5	4.5	5.1	6.5	**	**
Spiral 1:1 Reduction	Gear Strength	0.11	1.1	3.3	5.9	7.7	10.9	13.1	19	27	32
	1000 hr L ₁₀	*	*	2.4	3.3	4.1	5.1	5.7	7	9	10
	5000 hr L ₁₀	*	0.6	1.3	1.8	2.2	2.8	3.1	3.9	4.8	5.4
Spiral 3:1 Reduction	Gear Strength	0.02	0.2	0.5	1.0	1.3	1.8	2.1	3	4	5
	1000 hr L ₁₀	*	*	*	*	1.2	1.5	1.7	2	3	3
	5000 hr L ₁₀	*	*	0.4	0.5	0.6	0.8	0.9	1.1	1.4	1.6

- * Use gear strength ratings only.
- ** Pitch line velocity is too fast for proper gear lubrication depending on duty cycle. Intermitant operation may be allowed - call factory for evaluation and ratings. See rating explanation on Page 6. See important installation and lubrication information on Page 7.

***For a detailed performance & cost comparison
of Forged, Straight Cut, and Spiral gears,
see page 5 of these reference sheets.***

Bevel Gear Boxes Model 2726 – REFERENCE SHEETS

Other Models Available. For Instant Data, see www.vonruden.com.



07.08.03

Cross Reference Information:

Drawing dimensions shown on pages 3 & 4 should be used for initial comparison only. Use dimensions on a model-specific drawing once initial comparisons have been made. In addition to dimensions, other issues must be considered when comparing gear boxes.

These issues include:

- HP, torque and speed ratings
- Rotational direction of each shaft
- Lubrication fittings (if any)
- Drain port and breather locations
- Beveled gear type (forged, spiral, etc.)

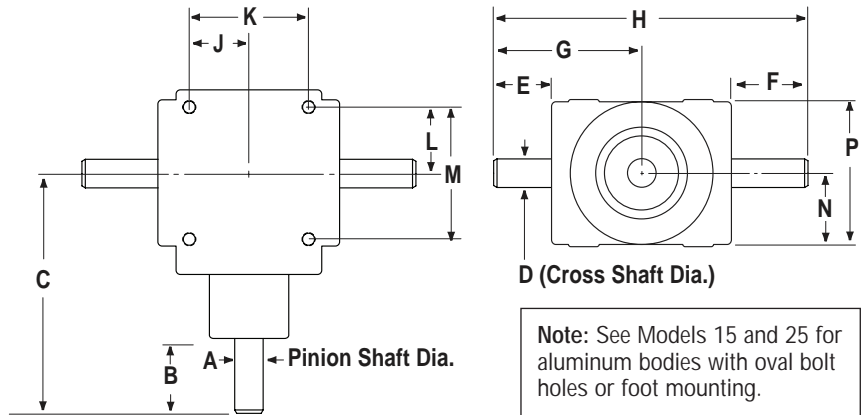

Important: Bevel gear boxes are often made with “special” modifications. This is especially true with shaft lengths and diameters. Always measure the actual dimensions on the box you are replacing.

CROSS REFERENCE CHART

(continues on page 4)

Manufacturer	Model	SHAFT DIAMETERS AND LENGTHS								CASE DIMENSIONS					
		A	B	C	D	E**	F**	G	H	J	K	L	M	N	P
Von Ruden	27	1.000	1.750	6.125	1.00	1.969	1.969	4.609	9.219	1.562	3.125	1.438	2.875	1.812	3.625
Von Ruden	2726	.750	2.125	5.625	.750	2.00	2.00	4.375	8.750	1.562	3.125	1.438	2.875	1.812	3.625
Hub City	M3	0.625	1.500	4.562	.0625	1.500	1.500	3.234	6.468	1.125	2.250	1.125	2.250	1.593	3.187
Curtis	200	0.750	1.062	4.687	0.750	1.000	1.000	3.375	6.750	1.562	3.125	1.438	2.875	1.812	3.625
Durst	A160	"	2.000	5.750	"	2.000	2.000	4.625	9.250	"	"	"	"	"	"
Von Ruden	33	1.000	2.000	6.125	1.000	1.781	2.062	5.093	10.18	2.125	4.250	2.125	4.250	2.062	4.125
Von Ruden	40	"	"	7.156	"	"	"	"	"	"	"	"	"	"	"
Hub City	150	"	"	5.179	"	#	#	5.093	10.18	"	"	"	"	"	"
Hub City	165	"	"	7.156	"	#	#	"	"	"	"	"	"	"	"
Browning	6H	"	1.750	6.125	"	1.625	1.625	4.546	9.218	#	4.375	#	2.750	2.125	4.250
Browning	9H	"	2.000	7.156	"	2.000	2.000	5.093	10.18	2.125	4.250	2.125	4.250	2.062	4.125
Boston Gear	R1211	"	"	5.500	"	"	-	5.500	-	"	"	"	"	"	"
(Made for Boston by Curtis)	R1214	"	"	7.375	"	"	2.000	"	11.00	"	"	"	"	"	"
	R1215/R1216	"	"	5.500	"	"	"	"	"	"	"	"	"	"	"
Curtis	211	"	"	"	"	"	-	"	-	"	"	"	"	"	"
Curtis	214	"	"	7.375	"	"	2.000	"	11.00	"	"	"	"	"	"
Curtis	215/216	"	"	5.500	"	"	"	"	"	"	"	"	"	"	"
Superior	200	"	"	6.875	"	"	"	5.590	11.18	"	"	"	"	"	"
Peerless	1100	"	#	#	"	#	#	#	#	"	"	"	"	"	"
Terrell	AB**	"	2.370	5.620	"	2.370	2.370	5.620	11.24	"	"	"	"	"	"
Prairie Gear	**	"	"	"	"	"	"	"	"	"	"	"	"	"	"
Durst	A115	"	2.000	6.120	"	#	#	5.062	10.12	"	"	"	"	"	"
Durst	A18/A101	"	2.500	8.620	"	2.500	2.500	6.250	12.5	2.000	4.000	2.000	4.000	2.810	5.62

CONTINUED NEXT PAGE

**Dimensions E and F are to end caps.

No dimension given in catalog.

Bevel Gear Boxes Model 2726 – REFERENCE SHEETS

Other Models Available. For Instant Data, see www.vonruden.com.



07.08.03

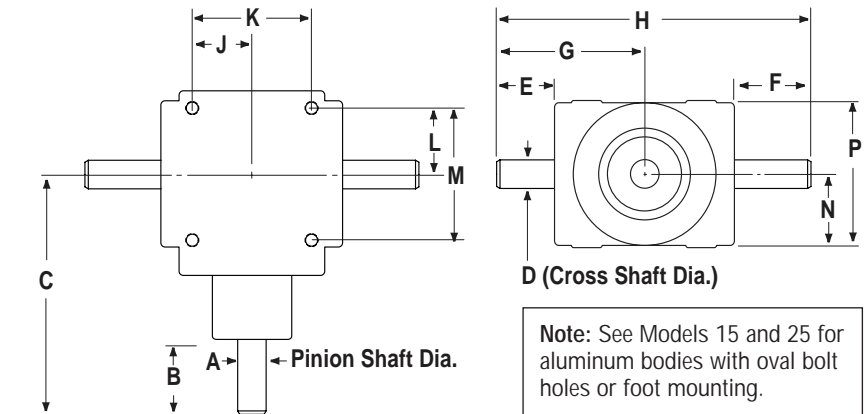

CROSS REFERENCE CHART (continued from page 3)

Manufacturer	Model	SHAFT DIAMETERS AND LENGTHS								CASE DIMENSIONS					
		A	B	C	D	E**	F**	G	H	J	K	L	M	N	P
Von Ruden	90	1.250	2.500	8.437	1.250	2.718	2.178	6.250	12.5	2.250	4.500	2.250	4.500	2.812	5.625
Hub City	66	"	"	8.468	"	#	#	6.125	12.25	"	"	"	"	"	"
Browning	12H	"	2.375	"	"	2.375	2.375	"	"	"	"	"	"	"	"
Boston Gear (Made for Boston by Curtis)	R1412/R1416 R1413 R1414	"	2.500	6.500	"	2.500	2.500	6.500	13.00	"	"	"	"	"	"
Curtis	412/416	"	"	6.500	"	"	"	6.500	13.00	"	"	"	"	"	"
Curtis	413	"	"	8.375	"	2.687	2.687	"	"	"	"	"	"	"	"
Curtis	414	"	"	"	"	2.500	"	8.375	16.75	"	"	"	"	"	"
Superior	400	"	"	8.500	"	"	2.500	6.625	13.37	"	"	"	"	"	"
Terrell	AE	"	2.620	8.620	"	2.630	2.630	6.380	12.76	1.875	3.750	"	"	3.375	6.750
Von Ruden	93	1.375	2.500	8.500	1.375	2.500	2.500	6.625	13.25	2.250	4.500	2.250	4.500	2.812	5.625
Terrell	314	"	"	"	"	"	"	6.690	13.38	"	"	"	"	"	"
Superior	500	"	"	"	"	"	"	"	"	"	"	"	"	"	"
Hub City	600	"	"	8.406	"	#	#	6.125	12.25	"	"	"	"	"	"
Hub City	88	"	3.000	10.87	"	#	#	7.906	15.81	3.250	6.500	3.250	6.500	4.093	8.187
Browning	15H	"	"	"	"	3.000	3.000	"	"	"	"	"	"	"	"
Boston Gear (Made for Boston by Curtis)	R1511/R1515 R1514	"	2.937	8.250	"	2.937	2.937	8.250	16.00	3.000	6.000	3.000	6.000	3.750	7.500
Curtis	511/515	"	"	8.250	"	"	"	"	"	"	"	"	"	"	"
Curtis	514	"	"	11.68	"	"	"	"	"	"	"	"	"	"	"
Durst	A-11	"	3.00	10.57	"	3.000	3.000	6.560	13.88	2.500	5.000	2.500	5.000	3.060	6.120
Durst	A-120	"	"	"	"	"	"	7.440	14.88"	"	"	"	"	3.500	7.000
Von Ruden	110	1.500	3.188	11.188	1.500	3.000	3.000	7.812	15.625	3.125	6.250	3.125	6.250	3.125	7.625
Von Ruden	113	1.750	3.000	11.125	1.750	3.000	3.000	8.375	16.75	3.250	6.500	3.250	6.500	4.062	8.125
Hub City	1000	"	"	13.00	"	#	#	9.140	18.28	4.000	8.000	4.000	8.000	4.750	9.500
Hub City	1010	2.000	4.000	15.00	2.000	#	#	10.75	21.50	"	"	"	"	"	"
Hub City	1200	2.500	5.000	16.87	2.500	#	#	12.81	25.62	4.500	9.000	4.500	9.000	6.187	12.37
Curtis	615	2.000	3.000	9.500	2.000	3.000	3.000	9.500	19.00	4.000	8.000	4.000	8.000	4.750	9.500
Durst	A-76	1.750	3.000	11.81	1.750	"	"	8.120	16.25	2.500	5.000	2.500	5.000	3.187	7.625
Terrell	176	1.375	3.375	11.68	"	"	"	7.688	15.37	2.375	4.375	3.000	6.000	4.500	9.000
Terrell	315	1.750	3.750	13.00	2.000	3.500	3.500	8.562	2.063	"	4.750	"	"	5.375	10.75

**Dimensions E and F are to end caps. # No dimension given in catalog.

Bevel Gear Boxes Model 2726 – REFERENCE SHEETS

Other Models Available. For Instant Data, see www.vonruden.com.



07.08.03

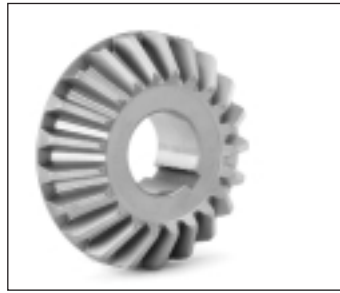

Gear Types

	Precision Forged	Straight Cut	Spiral
Horsepower	Highest. Forging process yields stronger metal grain structure. Also, forged gears can be designed with a web connecting the heel of teeth for increased strength.	Lower than forged.	Higher than straight cut. More teeth in continuous contact and increased tooth beam strength. But the thrust load imposed by spiral gears reduces bearing life.
Speed	Same as straight cut.	Same as forged.	Highest, due to better lubrication and contact.
Noise Level	Good	Improved over forged.	Best, more continuous tooth contact.
Cost/Gear (once tooled)	Relatively Low.	Moderate But set-up costs greatly influence price, especially in quantities less than 100.	Highest due to the extra machining required. Also, set-up costs influence cost significantly, especially in quantities less than 100.
Tooling Cost	Very high. Plus long lead time for tooling (months).	Low. Primarily a gear cutter.	Low. Primarily a gear cutter.
Economical Production Lot Size	High (1000s).	Low. But cost is influenced significantly by set-up, especially for less than 100.	Low. But cost is influenced significantly by set-up, especially for less than 100.

Backlash

Our Standard backlash is 0.004" minimum and 0.012" to 0.015" maximum. Other backlash can be provided on a special order basis.

We shim our gear boxes for consistent backlash using the process described below.

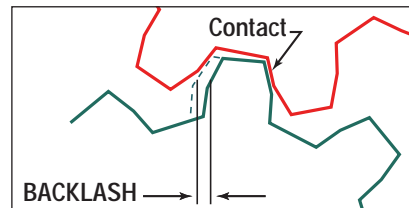

Backlash = The shortest distance between the non-contacting surfaces of adjacent gear teeth.

Shimming Procedure

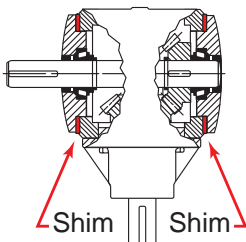

STEP 1

Shim bearings on cross shaft to acceptable end play of .003" to .001"

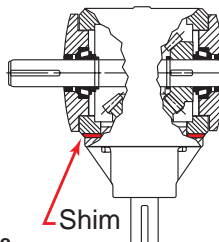

STEP 2

Shim pinion housing to achieve proper backlash and gear tooth contact

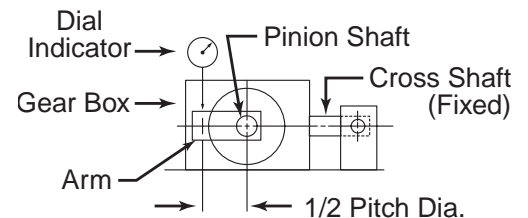

STEP 3

Measure backlash

All information is subject to change without notice. Always confirm with us that you are working with the most current data.

Bevel Gear Boxes Model 2726 – REFERENCE SHEETS

Other Models Available. For Instant Data, see www.vonruden.com.



07.08.03

Gear Box Ratings

Our strength and durability ratings are based on AGMA suggested guidelines, engineering calculations and our own actual experience. They should be used only as an initial selection guide.

We cannot guarantee that these ratings will prove satisfactory for all applications. Complete suitability can be determined only through prototyping and field testing.

AGMA Ratings

AGMA Ratings apply to gear material, heat treatment, design, tooth finish, tooth profile, and allowable tolerances.

Our straight cut and spiral gears are manufactured to AGMA Class 9 with forged gears manufactured to AGMA Class 7. Other AGMA classes can be provided.

Class of Service

Our ratings are based on AGMA Class 1 service conditions. A 1.00 service factor is used when the application is free from recurrent shock loading and is continuous but does not exceed 10 hours per day. For other operating conditions, the rated horsepower can be increased or decreased by dividing the rated horsepower by the proper service factor from this table.

Prime Mover	Duration of Service	DRIVEN MACHINE LOAD CLASSIFICATIONS		
		Uniform	Moderate Shock	Heavy Shock
Electric Motor	Occasional .5 hr/day	.0.50	.0.80	.1.25
	Intermittent 3 hrs/day	.0.80	.1.00	.1.50
	Up to 10 hrs/day	.1.00	.1.25	.1.75
	24 hrs per day	.1.25	.1.50	.2.00
Multi-Cylinder Internal Combustion Engine	Occasional .5 hr/day	.0.80	.1.00	.1.50
	Intermittent 3 hrs/day	.1.00	.1.25	.1.75
	Up to 10 hrs/day	.1.25	.1.50	.2.00
	24 hrs per day	.1.50	.1.75	.2.25
Single Cylinder Internal Combustion Engine	Occasional .5 hr/day	.1.00	.1.25	.1.75
	Intermittent 3 hrs/day	.1.25	.1.50	.2.00
	Up to 10 hrs/day	.1.50	.1.75	.2.25
	24 hrs/day	.1.75	.2.00	.2.50

Our Catalog Rating System

RPM	→	700
<hr/>		
HP based on gear strength	→	57.5
<hr/>		
HP based on 1000 hours L ₁₀ bearing life	→	41.6
<hr/>		
HP based on 5000 hours L ₁₀ bearing life	→	25.7
<hr/>		

Bearing Life Ratings

Our bearing life ratings are based on the L₁₀ life calculations which are an expression of reliability. There is a 90% reliability (100% less 10%) that the bearing life will equal or exceed the calculated hours listed.

We tabulate bearing ratings for both 1000 and 5000 hours of L₁₀ life.

Our calculations assume no externally applied thrust or radial loads. Bearing life can be calculated when external loads are applied, but our engineers need to know the location and direction of the external load as well as its magnitude. Use our application data sheet (DT176) when forwarding information.

Torque Ratings

Horsepower ratings are provided in these reference section. To determine torque, use this calculation.

$$T = 63.025 \frac{HP}{N}$$

T = Torque (Lb.-inches)
HP = Horsepower
N = RPM

Starting Torque

Momentary or starting torque should be limited to 200% of gear strength rated capacity.

Maximum Speeds

The maximum speeds listed in our catalog can be exceeded in some applications. Consult factory.

Bevel Gear Boxes Model 2726 – REFERENCE SHEETS

Other Models Available. For Instant Data, see www.vonruden.com.



07.08.03

Thermal Capacity

The thermal capacity of a gear box (Its ability to dissipate heat) may be somewhat less than the mechanical horsepower ratings included in this documentation. The thermal capacity is dependent on load conditions (duty cycle) and cooling air circulation.

Additional cooling or a larger gear box may be required if the continuous operating temperature exceeds 200°F.

Prototype testing is recommended.

Lubrication Specifications

All Standard Bevel Boxes are splash lubricated and splash cooled. Shafts must be mounted horizontally (+/-15°). When shafts are mounted vertically, an external grease fitting may be required. Please specify when ordering.

The input speed rating must not exceed the gear box's specification. Maximum continuous operating temperature for standard units is 180° F (82° C). The maximum intermittent operating temperature should not exceed 225° F (107° C) with a rest period at least five times the running period. (Consult Factory on applications with operating parameters exceeding these requirements).

- All standard bevel boxes are **shipped without lubrication**. Box must be filled at least to the oil check plug before operating.
- The oil level should be established according to the gearbox's speed and mounting position.
- Boxes running below 500 RPM require a slightly higher oil level. In very low RPM applications the oil may be replaced with grease (Consult Factory).
- Overheating can be caused by too little or too much oil in the box.
- Use ISO VG150 EP antifoaming oil for normal operations. Use ISO VG100EP or ISO VG150EP antifoaming oil for high RPM applications.
- Fill, check and drain plugs are located for applications where all shafts are in a horizontal position, unless otherwise specified.
- Breather and drain plug positions meet most mounting requirements, however end users are responsible for relocating the breather and drain plugs to meet Von Ruden's specifications.
- Special units equipped with grease fittings should be serviced regularly with a multi-purpose NLGI Grade No. 2 grease.

Approximate Oil Capacities

Models	15	25	27	33	40	90	93	110	113
Ounces (oz.)	4	8	6	16	16	24	32	56	80
Liters (L)	.1	.2	.15	.5	.5	.7	.9	1.7	2.4

Recommended Lubricants

Ambient Temp.	Lubricant
-20° to 0° F	SAE 10W or 10W-40 Automotive Oil
0° to 40° F	SAE 80 Gear Oil with Anti-Foaming Agent
40° to 100° F	SAE 90 Gear Oil with Anti-Foaming Agent
100° to 150° F	SAE 140 Gear Oil with Anti-foaming Agent

Lubrication Change Intervals

The lubricant in a new gear box should be changed after 100 hours of operation or four (4) weeks by draining at operating temperature, thoroughly cleaning with a flushing oil to remove any particles, and refilling with clean oil. Thereafter, under normal operating conditions, the lubricant should be changed every 2500 hours of operation or every six (6) months.

Under severe operating conditions such as dust or rapid temperature changes, the lubricant should be changed more frequently.

Note

Von Ruden reminds users of these products that their safe operation depends on use in compliance with engineering information provided by Von Ruden Manufacturing. Users are also reminded that safe operation depends on proper installation, operation, and routine maintenance and inspection under prevailing conditions. It is the responsibility of users (and not Von Ruden) to provide and install guards or safety devices which may be required by recognized safety standards or by the Occupational Safety and health Act of 1970 and its subsequent provisions.